

WDC-903M
WDC-903C
WDC-903D

 **Dante**[™]
Wireless Conference
Discussion System

Simple operation manual

Before using the product, please read the simple operation manual and keep it in good condition.



System Overview

Relacart launched a new generation of wireless conference discussion system WDC-903, with professional appearance design, perfect circuit composition and stable functional characteristics. It can be used with VTS-2000 automatic video tracking system and central control system to achieve functional diversification.

The data instructions of this wireless conference discussion system are transmitted using the LoRa protocol. The audio works in the UHF band. The high-fidelity circuit design can produce high-quality sound effects. The system has anti-interference protection, which can effectively block the influence of wireless devices such as computers, mobile phones and Bluetooth in the environment.

With automatic search function (AFS), it can automatically search for a free frequency backup and replace the frequency of the interfered working channel automatically. With automatic and manual activation of the microphone unit, the main controller can turn on the microphone unit automatically. In manual mode, you need to turn on the microphone unit manually in manual mode.

Unique and simple installation, easy and fast, and has no impact on the installation site, especially for the installation or layout of historical museums, ancient buildings and other historical and cultural buildings. Users do not need to worry about causing damage to ancient buildings. No wiring or drilling is required, providing a professional and perfect solution for demanding and complex applications.

This wireless conference discussion system is fully applicable to local government departments, corporate conference rooms, business venues, and international conference centers.

System performance feature

- LoRa protocol 433 MHz wireless control signal, UHF audio transmission technology.
- The system searches for non-interference channels automatically and replaces the interfered channels.
- Control up to 255 wireless discussion units and can speak up to 5 wireless units at the same time.
- The main controller can turn the microphone unit on and off automatically.
- With Dante interface, it can communicate with any Dante-equipped device to transmit audio.
- It has 4 conference modes including "FIFO", "Limited time", "Request", and "Sound activation" to meet different meeting needs.
- It is powered by a detachable lithium battery, which can be charged using the WDC-903 special charging case, or directly using the USB interface of the conference unit.
- The microphone unit can be set to manual or automatic power-on mode.
- It can work continuously (speaking state) for 23 hours under full power and 48 hours of standby (mute state). When the battery is fully charged, it can work for 90 days when the microphone function is turned off automatically.
- Bright OLED display with Chinese and English language menu selection, easy operation.
- Strong anti-interference function, which can block the influence of computer equipment, mobile phones and Bluetooth devices effectively in the environment.
- Equipped with an antenna interface, used in conjunction with the antenna system of the Relacart, the transmission signal is particularly strong.
- Multi wireless conference systems can be installed in the same building.
- Suitable for desktop or 19-inch (1U) rack mounting.
- You can easily install a temporary system, neat and clean, without any impact on the installation site.
- Cooperate with VTS-2000 automatic video tracking system to realize the automatic video tracking function of the conference.
- Equipped with RS-232 interface, which can connect various central control equipment.

Conference unit basic functions

- It is powered by a detachable lithium battery, which can be charged using the WDC-903 special charging case, or directly using the USB interface of the conference unit.
- The microphone unit can be set to manual or automatic power-on mode.
- It can work continuously (speaking state) for 23 hours under full power and 48 hours of standby (mute state). When the battery is fully charged, it can work for 90 days when the microphone function is turned off automatically.
- Bright OLED display which can simultaneously display battery capacity, speaking mode, time limit, etc.
- Strong anti interference of cell phone.
- With working indicator.
- Use high-quality condenser capsule to achieve high-quality sound pickup.
- Wireless conference technology can easily install a temporary system, neat and clean, without any impact on the installation site.

Packing List

WDC-903

- ◆ Wireless conference system main controller * 1
- ◆ BNC antenna * 2
- ◆ Power cable * 1
- ◆ 1 meter audio cable * 1
- ◆ Simple operation manual * 1

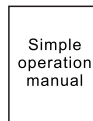
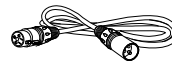
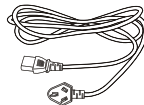

Options

Antenna options

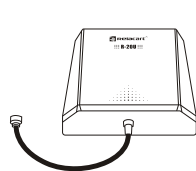

R-20U
panel antenna

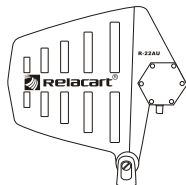

R-22AU
directional antenna

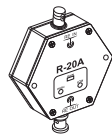

R-20A
active antenna booster



R-43W
Rod antenna

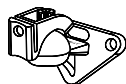

Wall-mounting bracket

- 1 R-20U panel antenna: beautiful appearance, wall mounting, high gain, wide range of receiving and transmitting signals.
- 2 R-22AU directional antenna: It has the feature of reliable performance, durability, which can provide the best reception effect within the required range. It has gain adjustment, and it can adjust the gain intensity according to the use distance.
- 3 R-20A active antenna booster: Provides gain amplification of the receiving antenna to compensate for signal attenuation on long-distance connection cable and expand the working range and stability of wireless systems.
- 4 R-43W rod antenna: N-type male XLRs, connected to DC-903 data communication converter, high gain, 360° receiving/transmitting signal, can provide stable signal transmitting / receiving effect for data communication converter.
- 5 Wall-mounting bracket: It can be fixed on the wall, there is a sliding bracket, and the antenna angle can be adjusted after installing the antenna.

GF removable conference microphone



GF 101



GF 301

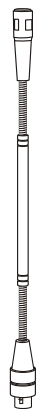

GF 501



GF 901

- 1 Locked three-pin balanced Cannon female microphone, can firmly lock the conference microphone base to prevent loosening or various failures caused by poor contact.
- 2 With LED indicator, you can know the working status of the microphone through the LED indicator.
- 3 RFI shielding technology can suppress external radio frequency interference effectively.
- 4 Different model and lengths are available.

Front Panel Functions of the Main Controller

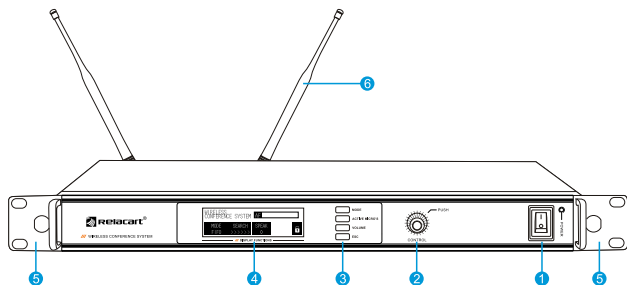

- 1 POWER switch (with indicator light).
- 2 Function knob: Press and hold for 3 seconds to enter the function selection menu, select the menu clockwise / counterclockwise, and press to set the system operation menu.
- 3 Shortcut function buttons:
MODE: short press to enter conference mode selection interface.
ACTIVE MICRO'S: short press to enter the microphone to open the number of speech selection interface.
VOLUME: short press to enter the volume adjustment interface.
ESC: Exit key, short press to exit to the previous menu.
- 4 OLED display interface.
- 5 Rack mount kit: fixed installation.
- 6 1/2 wavelength BNC antenna: It used to receive radio waves transmitted by the transmitter.

Main controller rear panel function introduction

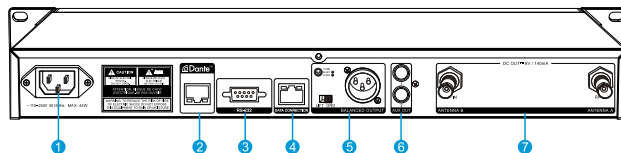

- 1 Power input socket: standard IEC socket, can adapt to work at 100-240V 50 / 60Hz AC power.
- 2 Dante network port: can connect Dante-supporting equipment.
- 3 RS-232 interface: can be connected to the automatic video tracking system VTS-2000 or other central control systems to achieve video tracking.
- 4 LoRa data communication port: connect DC-903 data communication converter, and then connect to external transmitting and receiving antenna through DC-903.
- 5 Balanced audio output socket: XLR male socket can be connected to the audio input of the mixer and other equipment using standard two-core shielded cable.
- 6 RCA audio line output: can be connected to mixers or recorders and other equipment.
- 7 BNC female connector: connect UHF antenna, can also connect R-20A antenna booster and R-20U / R-22AU external antenna to enhance the signal receiving distance.

Microphone unit function introduction

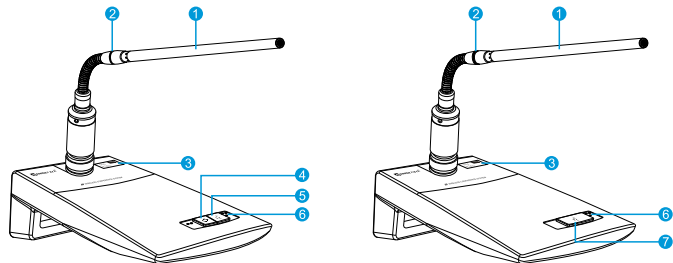

(Chairman unit)
top view

(Delegate Unit)
top view

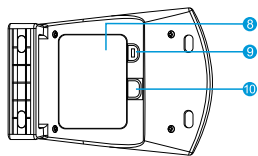

Bottom view

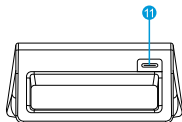

Rear view

- 1 Super cardioid directional: High-quality condenser microphone provides clear and full sound quality, high sensitivity, and good long - distance pickup effect.
- 2 Working status indicator: The light is off when muted, the light is on when speaking, the light flashes when waiting for the application, and it will flash when the battery is dead.

- 3 OLED display: display the working status of the microphone, including conference mode, speaking status, battery indication, ID address, speaking channel light information.
- 4 Chairman unit priority button: Allow the chairman unit to close the delegate unit that is speaking. When applying for the speaking mode, the chairman unit can use this button to disapprove the delegate unit for the application to speak.
- 5 Chairman unit speech button:
 - a. When mute, press the button microphone to speak, and then press the button microphone to mute.
 - b. When turned off, press and hold for 1 second to turn on the microphone; when turned on, press and hold for 3 seconds to turn off the microphone.
 - c. In the case of shutdown, press and hold for 3 seconds to enter the "ID pairing" state.
- 6 Braille logo: Braille text, which is convenient for people who have congenital defects or damage to the eyes to make them invisible.
- 7 Speech key of the delegate unit:
 - a. When mute, press the button microphone to speak, and then press the button microphone to mute.
 - b. When turned off, press and hold for 1 second to turn on the microphone; when turned on, press and hold for 3 seconds to turn off the microphone.
 - c. In the case of shutdown, press and hold for 3 seconds to enter the "ID pairing" state.
- 8 Removable lithium battery box: It provides power for the microphone unit, rated capacity 2900mAH, rated voltage 3.7V.

⑨ Manual / automatic switch:

- a. When the switch is set to "AUTO", the microphone unit is switched to the automatic power - on mode. When the microphone unit is turned off, as long as it receives the power-on signal from the main controller, the microphone unit will automatically power on.
- b. When the switch is set to "MANUAL", the microphone unit is switched to the manual power-on mode. The microphone unit cannot receive the power-on signal transmitted by the main controller, and the microphone unit needs to be turned on manually.

(Note: In the case of shutting down and removing the battery box, when you switch the switch from "MANUAL" to "AUTO", you need to manually turn on the microphone unit once and then turn it off before the microphone unit can start the automatic power-on mode.)

⑩ Battery sliding shutter.

- ⑪ TYPE - C charging port: It can charge the lithium battery of the microphone unit, the charging rated voltage is 5V, and the charging rated current is 800mA.

DC-903 LoRa Data Communication Converter Function Introduction

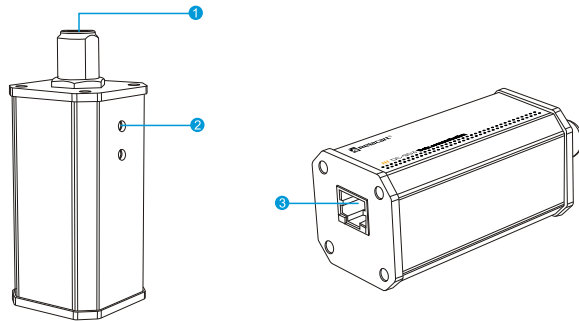

- ① Antenna input port: N-type female connector, which can be connected to 400-450MHz LoRa antenna.
- ② Screw port: screw port for wall mount.
- ③ Data communication connection port: RJ45 interface, connected by DC-903 to DATA CONNECTION end of WDC-903M.

Setup and operation

Before the meeting starts, make the corresponding setup for the main controller according to the needs of the meeting, and use the shortcut keys and function coding knobs on the front panel of the main controller to set.

A. Startup main interface

After turn on the power switch, the WDC-903M main controller starts searching for online microphone units for 75 seconds. After the search is completed, the number of online microphone units is displayed.



B. Pair the microphone unit with the main controller

The microphone unit needs to be paired with the main controller before data communication. The unpaired microphone will display the "NO PAIRING" interface after it is powered on. The microphone can only work normally after it is paired with the main controller.

The pairing operation is as follows:

① Press and hold the coding knob on the main controller panel for 3 seconds to enter the operation interface, select "Conference Setup" - "ID pairing", the main controller display shows "Pairing.....".

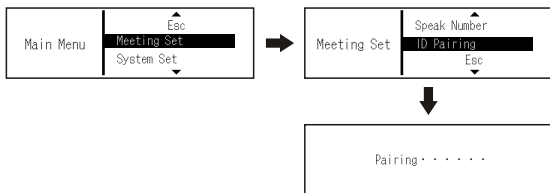

② In the microphone off state, press and hold the speaking button of the microphone for 3 seconds until the display shows the "PAIRING....." interface. Then you can release the buttons. At this time, the main controller and the microphone will establish a pairing relationship. After the pairing is completed, the microphone displays a "√" interface and automatically turns off the microphone.

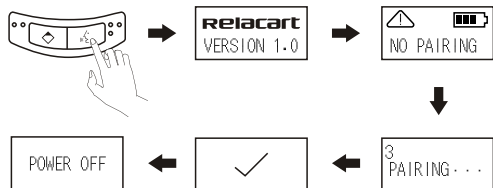

③ After all the microphone units have been paired, the main controller exits the "Matching....." and returns to the main interface. Then, when the microphone is turned on, the microphone can work normally.

C. Main controller setup

① Press the MODE button on the main controller to enter the conference mode setup. Rotate the coding knob to select one of the four speaking modes: "First-In-First-Out", "Limited-Time", "Request", and "Voice-activation".



First-In-First-Out: can active (1 / 2 / 3 / 4 / 5) microphone units in a time. When speaking microphone over the limit number of speakers who spoke first will be override. (The chairman unit is not limited) to keep the total number of open speaking units.

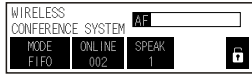

Main controller

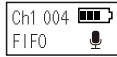

Microphone unit

Limited-Time: Allow maximum 5 speaking units, and can set the microphone to open 1min to 100 min, when the limited time is reach, subsequent microphone speaks. (The chairman unit is not limited).

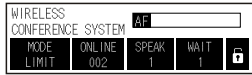

Main controller



Microphone unit

Request: The operation of delegate unit should be approved by chairman unit.

- Chairman's microphone unit approval:

When applying for the speaking mode, the chairman unit has been speaking for a long time. When a delegate unit requests to speak, press the speak button to allow the delegate unit, and press the priority button to reject the delegate unit.

- Main controller default approval:

"enable speak" means that the main controller passes by default when the chairman unit has not approved.

"disable speak" means that the main controller does not pass the delegate unit by default when the chairman unit has not approved.

"REQUES" shown on the display when the delegate unit requests to speak. The microphone indicator light will flash, and the chairman unit display will show the ID code of the delegate unit and "REQUES" flashing. At this time, the chairman unit can approve or reject to speak. After the delegate unit speaks 20 seconds, if the chairman unit does not approve it, the main controller will approves it by default. When the number of microphone speeches has reached the preset number of turns on (1 / 2 / 3 / 4 / 5), the delegate unit request to speak later is in a waiting state (the main controller displays the number of microphone speeches and the number of waiting speeches). When the delegate unit is passed, it will turn off the first one to maintain the total number of open speech units.

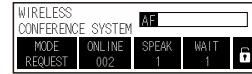

Main controller



Microphone unit

Voice activation: When the sound pressure picked up by the microphone unit is greater than the preset threshold, the speech will be automatically turned on. The sound pressure threshold can be set by the "Sensitivity" setting. When set the "Sensitivity" higher, and the lower of sound pressure threshold, it can easier turn on the microphone. Only one delegate unit can speak the under voice activation mode, when the maximum number of speakers is reached, subsequent microphone speaks.

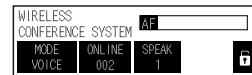

Main controller



Microphone unit

② Press the ACTIVE MICRO'S button on the main controller panel to enter the number of speaking unit setting interface. Turn the encoder knob to select the number of microphone units that can speak at the same time. There are 1.2.3.4.5 number options respectively.



③ Press the VOLUME button on the main controller panel to enter the volume setting interface. You can set the volume by selecting the "Main Volume" Setting and "Dante Volume" Setting by turning the encoder knob.

- Main volume setting: Control the master volume output of the main controller.
- Dante volume setting: control the volume of Dante device input to the main controller.



④ Press and hold the coding knob for 3 seconds to enter the menu selection interface. The menu structure is shown below:

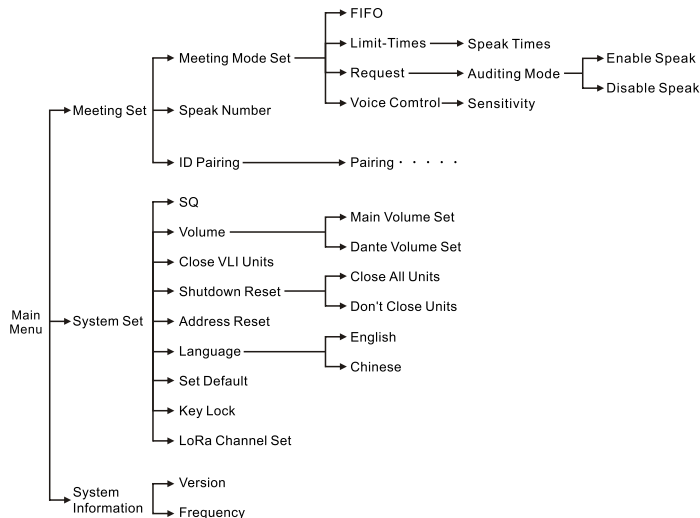

- 1) The conference setup includes three menu items: "Conference Mode", "Speaker Number" Setting, and "ID Pairing". For specific function operations, please refer to the description above.
- 2) System setup include nine menu items: "Squelch" setting, "Volume" setting, "Close all units", "Power Off Setting", "Address reset", "Language" setting, "Ret Default", "Key lock", "LoRa Channel Setup".

- a. Squelch: 0dB to 35dB can be selected according to the application and environment.
 - b. "Volume" setting: Please refer to the operation instructions of the panel shortcut key "VOLUME".
 - c. "Close all units": All microphone units are turned off.
 - d. "Power Off Setting": "Auto Mic Off" means that the microphone unit will be turned off when the main controller is turned off. "Disable Auto Mic Off" means that the microphone unit will not be turned off when the main controller is turned off.
 - e. "Address reset": Reset the IP address. All microphone units need to be "IP paired" to obtain the address before they can be used.
 - f. "Language" setting: English and Simplified Chinese for optional.
 - g. "Ret Default": The main controller is restored to the factory settings.
 - h. "Key lock": The main controller's keys are locked, and the function menu cannot be selected. The lock icon on the main controller's main interface is closed. Selecting the function menu indicates "Key lock".
 - i. "LoRa Channel Setup": There are 8 channels to choose. When using more than 2 sets of WDC-930 wireless conference systems on the same occasion, the LoRa channels must be staggered, otherwise crosstalk will occur between the systems.
- 3) System information: You can view the system software version information.

Microphone unit display overview

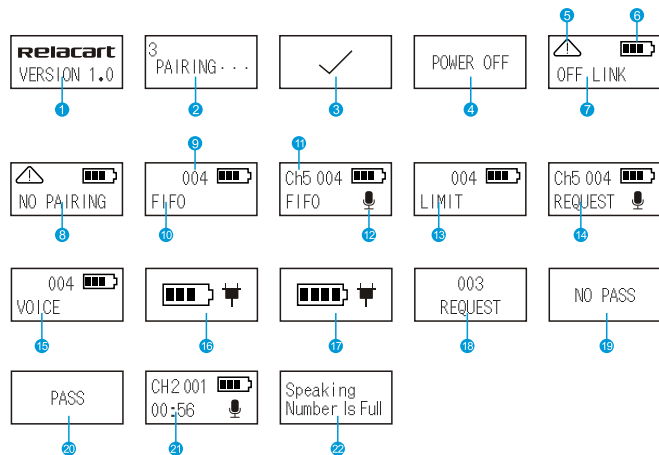

- ① RELACART Logo and software version information.
- ② ID pairing interface, indicating that the microphone unit is performing ID pairing operation with the main controller.
- ③ Display interface after ID pairing is successful.
- ④ Shutdown display interface.
- ⑤ Indicates that the microphone unit and the main controller key have not established communication or have malfunctioned.
- ⑥ Battery level display.
- ⑦ "OFF LINK" indicates that the microphone unit and the main controller key have not established communication.

- 8 "NO PAIRING" indicates that the microphone unit has not yet been ID-paired with the main controller.
- 9 Microphone unit ID.
- 10 "FIFO" stands for FIFO mode.
- 11 Indicates that the microphone unit occupies the main controller's RF channel.
- 12 Indicates that the microphone is speaking.
- 13 "LIMIT" stands for time-limited speaking mode.
- 14 "REQUEST" means request to speak mode.
- 15 "VOICE" means voice activation mode.
- 16 Indicates that the battery is charging.
- 17 The battery is fully charged.
- 18 When the delegate unit requests to speak, the interface displayed by the chairman unit will flash "REQUEST" and "003" The delegate unit ID of the application.
- 19 In the application mode, the chairman unit does not apply to speak through the delegate unit.
- 20 In the application mode, the chairman unit requests to speak through the delegate unit.
- 21 In the time limit mode, the time limit displayed when the delegate unit speaks.
- 22 Indicates that the speaking unit has exceeded the maximum number of speakers.

System application connection diagram

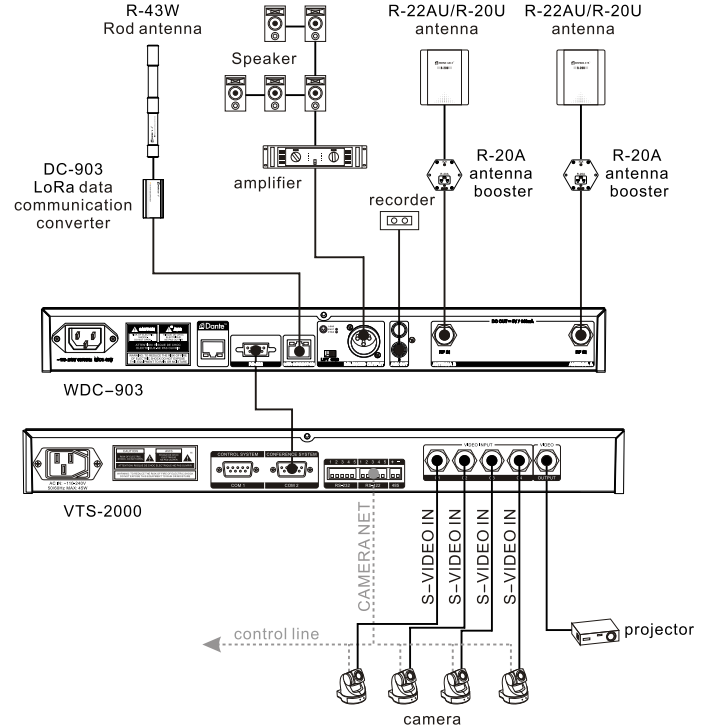

Factors affecting wireless signal transmission in the system:

In order to ensure that the digital wireless conference system can work normally, all signal transmission must not be disturbed.

In addition to using sufficient transmitting and receiving antennas, they must be placed in a reasonable position to ensure that. The wireless signal transmission is uniform and consistent with all wireless conference units in the conference venue.

When planning a digital wireless conference system, factors that affect signal uniformity and strength must be considered.

Installation of wireless transceiver antenna:

Wireless transmission is non-directional and will not be affected by visible light. All the transmitting antennas can for outdoor use, since the transmission is non-directional, the transmitting antenna is installed in the venue where it is used. Do not install it in the control room, because the transmitting power of the transmitting antenna is only 10mW, and the penetration ability is relatively small. The linear stable transmission distance is about 30 meters. All transmitting antennas must be as close as possible to the infinite conference list. When using a directional antenna, the wireless conference unit has the best sensitivity when facing the transmitting and receiving antenna. And transmit there must be no obstacles in the space.

Transmitting antenna, no metal near the installation location.

Specification

WDC-903M

Chassis specifications:	EIA Standard 1U
Receiving channel:	Six channels
Frequency stability:	± 0.005%
Carrier frequency band:	UHF 522~936MHz
Sampling rate:	48KHz / 24bit
Modulation:	FM
Effective working distance:	80 meters (open space)
Oscillation:	PLL frequency synthesis
Band width:	32MHz
Maximum offset:	± 45KHz
Comprehensive S / N:	> 100dB
Comprehensive THD:	<0.5%@1KHz
Comprehensive frequency response:	50Hz~18KHz
Output:	XLR balanced XLR male 2 lotus mother seats
Power supply:	AC110-240V 50 / 60Hz
Size(mm):	480(L) x 43(H) X 350(D)
Weight:	about 3.2Kg

WDC-903 C/D

Carrier frequency band:	522~936MHz
Oscillation mode:	PLL frequency synthesis technology
Harmonic radiation:	45dBm below the main wave
Band width:	134MHz
Maximum offset:	± 45KHz
Input socket:	three-pin XLR male socket
RF output power:	30mW
Power supply:	Li-ion polymer rechargeable battery, 3.7V / 2900mA
Current consumption:	120mA (typical) 60mA (standby mute)
Working time:	23 hours (typical) 48 hours (standby mute)
Size(mm):	162 (L) x 125 (W) x 54(H)
Weight(g):	about 910g

DC-903 data converter

Operating frequency range:	400~450MHz
Gain:	16dBm
RF input:	N female
Data communication port:	RJ45
Power supply:	data line and power line integrated power supply
Material:	Black anodized aluminum (package)
Size(mm):	42 (W) x 42 (D) x 105 (H)
Weight(g):	about 150g

R-22AU directional antenna

Frequency range:	520~960MHz
Gain:	6dB
Booster gain:	15dB
Output:	OIP3 > 28dBm
Input impedance:	50 Ω
Connector type:	BNC female
Size(mm):	258(W) x 263(H) x 1.6(D)
Weight(g):	about 220g

R-20U panel antenna

Frequency range:	600~900MHz
Standing wave ratio:	≤ 2
Gain:	7dB
Input impedance:	50 Ω
Polarization method:	vertical
Front-to-back ratio:	≥ 25dB
Horizontal plane lobe width:	80°
Vertical lobe width:	60°
Connector type:	BNC female
Size(mm):	210(H) x 180(W) x 44(D)
Weight(g):	about 300g

R-43W Rod Antenna

Frequency range:	400MHz~950MHz 2000MHz~2500MHz
Gain:	9dB
Standing wave ratio:	≤2
Input impedance:	50 Ω
Connector type:	N-type male
Size(mm):	φ 36.5 x 376
Weight(g):	about 220g

GF series conference microphone

Model:	GF 101
Microphone type:	Condenser
Directivity:	Cardioid
Frequency response:	100~15000Hz
Signal to noise ratio:	>52dB/1KHz at 1Pa
Sensitivity:	-47dB/1KHz at 1Pa
Maximum input sound pressure level:	105dB SPL/1KHz at 1%THD
Output impedance:	680 Ω
Interface Type:	integral three-Pin Balanced XLR type
Length (mm):	455mm
Weight (g):	165g

Model:	GF 301
Microphone type:	Condenser
Directivity:	Cardioid
Frequency response:	100~15000Hz
Signal to noise ratio:	>52dB/1KHz at 1Pa
Sensitivity:	-47dB/1KHz at 1Pa
Maximum input sound pressure level:	105dB SPL/1KHz at 1%THD
Output impedance:	680 Ω
Interface Type:	integral three-Pin Balanced XLR type
Length (mm):	415mm
Weight (g):	195g

Model:	GF 501
Microphone type:	Condenser
Directivity:	Cardioid
Frequency response:	100~15000Hz
Signal to noise ratio:	>52dB/1KHz at 1Pa
Sensitivity:	-47dB/1KHz at 1Pa
Maximum input sound pressure level:	105dB SPL/1KHz at 1%THD
Output impedance:	680 Ω
Interface Type:	integral three-Pin Balanced XLR type
Length (mm):	412mm
Weight (g):	190g

Model:	GF 901
Microphone type:	Condenser
Directivity:	Super Cardioid
Frequency response:	100~15000Hz
Signal to noise ratio:	>55dB/1KHz at 1Pa
Sensitivity:	-43dB/1KHz at 1Pa
Maximum input sound pressure level:	110dB SPL/1KHz at 1%THD
Output impedance:	680 Ω
Interface Type:	integral three-Pin Balanced XLR type
Length (mm):	175mm
Weight (g):	195g